



TEAM STAR

Complete Washing & Laundry Solutions.

All kinds of industrial Washing & Textile machineries manufacturer , importer & supplier.

Industrial automation & complete engineering solution.





Message

Dear Valued Customer

I feel proud to engage myself in this textile washing sector & it's our pleasure to introduce us as a washing plant Consultant Service, Manufacturer/Importer of Standard Wet & Dry Process Machines using Turkish Technology & Spares.

We have vast experience and sound knowledge of Garments Washing technology since 1998 & we are producing different types of capital machines to fulfill the customer requirements & satisfaction.

Md. Asaduzzaman
Managing Director
TEAM STAR





Team Star started its journey in 2009. we produce all types of wet & dry process machines related with washing plant as well as accessories importer & supplier. Team star be comparable with European standards & fulfill its production in accordance with these standards without any harm of human health & environment.

we create a good platform in this sector within a very short time for our reliable business policy along with experienced staff & workers. Till now Team Star is the biggest workshop in Bangladesh which is renowned for their good quality & goodwill.

Ours technology is by Turkey.

WE PROVIDE QUALITY SERVICE



We always give values to the customer. what they need & what they want is the main focus of us. we make machines as per our customer's requirement. we never compromise with quality. To us , quality is what customer need . we have an individual experienced engineer & support team for giving after sales service to our customer . we believe a great company , weather improving a sector or creating a new one , needs to have an excellent quality product and service at its core.



We provide and ensure best solution for any kinds of industrial automation and engineering solution.

We also do all erection work of water line , steam line , air line & piping system as well as intallation of boiler & compressor.

We are manufacturer & consultant of washing plant wet & dry process machineries in Bangladesh, our company also trades machines for wet and dry process form Turkey & China as per customer requirement. As well as we do manufacture pharmaceutical's machineries.



Frontloading Washing & Dyeing Machine



Giving Denim Solutions in European Way.....

- Totally European Standard Features.
- Dual Auto Locking with Sampling Door
- Less Amount Of Water & Chemical.
- Less Handling Cost & Less Damage Risk For Sensitive Garments.



Frontloading Washing & Dyeing Machine



- Our First Priority is to protect life and not to waste natural resources in the principle of sustainability.
- Our Machine is suitable for all kinds of washing types and gives a complete solution to its user.
- MTK Washing machine series is designed to achieve the perfect results in washing process.
- We have the highest technology of any sustainable machines such as PLC Automation, touch screen controller & water flow meter.
- Lowest gap between inner & outer drum so that customer get lowest water ratio.

Model No	Drum Dimension		Motor Power (KW)	Steam Consumption (kg/H)
	Diameter (mm)	Depth (mm)		
MTK- F.W 50	Ø 530	225	0.75	5
MTK- F.W 250	Ø 800	500	1.2	20
MTK- F.W 575	Ø 1000	730	2.2	50
MTK- F.W 1290	Ø 1350	900	4	85
MTK- F.W 2120	Ø 1500	1200	9	150
MTK- F.W 3880	Ø 1845	1450	18.5	250
MTK- F.W 4670	Ø 1855	1728	22	300
MTK- F.W 5215	Ø 1855	1930	22	325

Frontloading Washing & Dyeing Machine



**The Earth is our home and the environment is a protective layer
That keeps us safe from things that can severely damage all living beings.
We can ensure that our product do not hurt our nature.**



Giving you less handling cost & less damage risk for sensitive garments



Frontloading Washing & Dyeing Machine



- MTK Frontloading Washing Machine Series is designed which is reducing the usage of resources such as water , Steam ,Chemical and providing shorter process time.
- Our Machine is suitable for all kinds of washing types and gives a complete solution to its user.
- We have the highest technology of any sustainable machines such as PLC Automation , touch screen controller & water flow meter.
- Lowest gap between inner & outer drum so that customer get lowest water ratio.

Model No	Drum Dimension		Motor Power (KW)	Steam Consumption (kg/H)
	Diameter (mm)	Depth (mm)		
MTK- F.W 50	Ø 530	225	0.75	5
MTK- F.W 250	Ø 800	500	1.2	20
MTK- F.W 575	Ø 1000	730	2.2	50
MTK- F.W 1290	Ø 1350	900	4	85
MTK- F.W 2120	Ø 1500	1200	9	150
MTK- F.W 3880	Ø 1845	1450	18.5	250
MTK- F.W 4670	Ø 1855	1728	22	300
MTK- F.W 5215	Ø 1855	1930	22	325

Keeping Your Garments More Absorbed

Low water liquor ratio , Save water & Save Chemical.

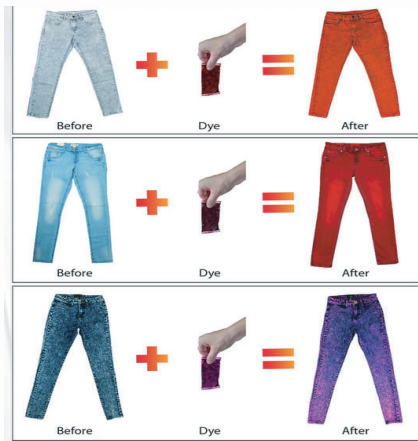
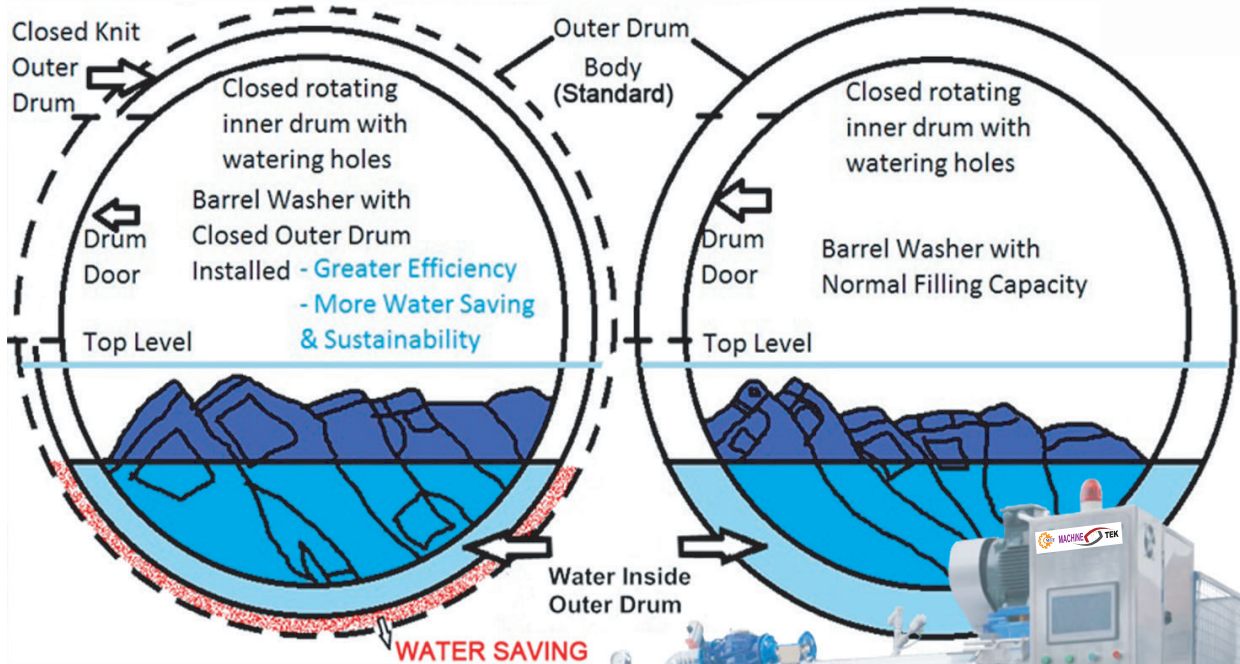

Belly Washing Machine



- Industrial Washing Machine is suitable for washing and fermenting all kinds of cotton , denim, knitting , chemical fiber and other fabrics.
- Its inside and outside are high quality 304 stainless steel , smooth and bright , longer machine life.
- Reasonable design , easy operation , leading position in domestic counterparts.
- It is an ideal product for utility models , lowest gap between inner & outer drum , low water ratio.
- We have the highest technology of any sustainable Machines such PLC Automation , touch screen controller & water flow meter.

Model NO	Capacity (LBS)	Drum Dimension (mm)	Overall Dimension (mm)	Motor Power (KW)
MTK - 10W	10	ø 460 X 370	1060 X 800 X 980	0.75
MTK - 20W	20	ø 600 X 470	1160 X 900 X 1100	0.75
MTK - 30W	30	ø 720 X 470	1300 X 1200 X 1250	1.1
MTK - 40W	40	ø 760 X 570	1400 X 1250 X 1250	1.1
MTK - 50W	50	ø 760 X 670	1500 X 1250 X 1250	1.5
MTK - 60W	60	ø 820 X 670	1500 X 1310 X 1300	1.5
MTK - 70W	70	ø 820 X 770	1600 X 1310 X 1300	1.5
MTK - 80W	80	ø 890 X 770	1600 X 1380 X 1500	1.5
MTK - 100W	100	ø 920 X 870	1700 X 1540 X 1540	2.2
MTK - 120W	120	ø 980 X 870	1700 X 1600 X 1600	2.2
MTK - 150W	150	ø 1000 X 1000	1830 X 1650 X 1650	2.2

Model NO	Capacity (LBS)	Drum Dimension (mm)	Overall Dimension (mm)	Motor Power (KW)
MTK - 200W	200	ø 1070 X 1200	2030 X 1720 X 1750	3
MTK - 250W	250	ø 1070 X 1360	2400 X 1720 X 1900	4
MTK - 300W	300	ø 1100 X 1480	2550 X 1750 X 1950	4
MTK - 450W	450	ø 1100 X 2230	3250 X 1820 X 1950	5.5
MTK - 500W	500	ø 1170 X 2230	3250 X 1850 X 1980	7.5
MTK - 550W	550	ø 1220 X 2230	3250 X 1950 X 2030	11
MTK - 600W	600	ø 1260 X 2230	3250 X 1980 X 2050	11
MTK - 650W	650	ø 1300 X 2280	3280 X 2050 X 2130	11
MTK - 800W	800	ø 1400 X 2290	3450 X 2100 X 2350	15
MTK - 1000W	1000	ø 1500 X 2730	3900 X 2250 X 2500	18

Acid Washing Machine



Acid Wash Effect

Durable Acid Washing Machine.
Easy to Use Wash Controls.

Giving a New Rock Style Look on your Denim with Durable Stone washing.



Hydro Extractor Series



- MTK Hydro Extractor Series are use centrifugal technology to quickly remove moisture from various chemical fiber blends , cotton and linen fabrics.
- The Cage and the shell are made of high quality 304 stainless steel with fine meshes and resonable tilt which facilitates the uniform distribution of dewatered materials.
- Large Capacity dewatering equipment designed for bleaching, dyeing and washing industry.
- The design provides a quick, self-balancing noiseless and vibration less performance.
- High capacity, efficient and with a low energy consumption.

Direct Drive :



MADE IN CHINA

Model NO	Capacity (KG)	Drum Dimension (mm)	Overall Dimension (mm) (L X W X H)	Drum Motor Power (KW)	Weight (KG)
MTK - 1250 H	200	ø 1250 X 600	1900 X 1850 X 1100	7.5	2200
MTK - 1550 H	500	ø 1500 X 600	2550 X 1950 X 2400	10	3000
MTK - 1800 H	650	ø 1800 X 780	2650 X 2100 X 2800	15	3500

Belt Drive :



Model NO	Capacity (KG)	Drum Dimension (mm)	Overall Dimension (mm) (L X W X H)	Drum Motor Power (KW)	Weight (KG)
MTK - 60 H	60	ø 630 X 300	1450 X 1020 X 750	3	560
MTK - 90 H	90	ø 900 X 380	1920 X 1465 X 920	5.5	1700
MTK - 110 H	110	ø 1070 X 400	2100 X 1600 X 1050	7.5	2000
MTK - 125 H	125	ø 1200 X 410	2200 X 1720 X 1050	11	2500



Frontloading Dryer Machine



- MTK Dryer Series are designed to perfect results for drying process with minimum consumption of steam or gas , energy and time.
- MTK Dryer Series are automatically controlled by an electrical control panel.
- It's feature is high efficiency and low energy consumption.
- We have the highest technology for dryer machines such as PLC automation , touch screen controller & Inverter.
- MTK Dryer Series (Gas or Steam) are available in different models with different capacities and sizes.
- The new generation dryers solve a big problem which is normal dryer wasting heat energy , moreover , Saving energy and high efficient.

Model NO	Drum Dimension (mm)	Overall Dimension (mm) (L X W X H)	Drum Motor Power (KW)
MTK - F.D 445	Ø 900 X 700	1150 X 1000 X 1600	1.5
MTK - F.D 865	Ø 1050 X 1000	1400 X 1100 X 1800	1.5
MTK - F.D 1245	Ø 1200 X 1100	1800 X 1400 X 2000	2.2
MTK - F.D 2155	Ø 1500 X 1220	2050 X 1800 X 2400	4
MTK - F.D 3065	Ø 1700 X 1350	2250 X 2150 X 2750	5.5
MTK - F.D 3820	Ø 1800 X 1500	2450 X 2250 X 2820	7.5
MTK - F.D 4680	Ø 1900 X 1650	2650 X 2350 X 2850	7.5
MTK - F.D 5430	Ø 2032 X 1677	2895 X 2465 X 2900	7.5
MTK - F. D 5870	Ø 1955 X 1955	3200 X 2360 X 2718	7.5



Dryer Machine



Energy Efficiency Dryer



Steam / Gas Heated Dryer

- MTK Dryer Series (Gas or Steam) are available in different models with different capacities and sizes.
- Energy efficiency dryer is a new generation dryer whose feature is high efficiency and low energy consumption.
- It's feature is high efficiency and low energy consumption.
- MTK Dryer Series are automatically controlled by an electrical control panel.
- We have the highest technology for dryer machines such as PLC automation , touch screen controller & Inverter.

Model NO	Capacity (LBS)	Drum Dimension (mm)	Overall Dimension (mm) (L X W X H)	Drum Motor Power (KW)
MTK - 100 D	100	∅ 1016 X 970	1665 X 1100 X 2240	1.1
MTK - 120 D	120	∅ 1200 X 970	1850 X 1100 X 2430	1.5
MTK - 150 D	150	∅ 1200 X 990	1870 X 1100 X 2430	2.2
MTK - 200 D	200	∅ 1372 X 1067	1947 X 1275 X 2600	2.2
MTK - 250 D	250	∅ 1425 X 1170	2050 X 1328 X 2650	3.7
MTK - 300 D	300	∅ 1524 X 1220	2100 X 1428 X 2750	4
MTK - 400 D	400	∅ 1676 X 1220	2100 X 1580 X 2800	4
MTK - 450 D	450	∅ 1778 X 1220	2100 X 1682 X 2850	4
MTK - 500 D	500	∅ 1880 X 1220	2100 X 1784 X 2900	5.5
MTK - 550 D	550	∅ 1880 X 1270	2170 X 1784 X 2900	5.5
MTK - 600 D	600	∅ 1880 X 1372	2272 X 1784 X 2900	7.5
MTK - 650 D	650	∅ 2032 X 1372	2272 X 1936 X 3050	7.5

3D Crinkle Machine

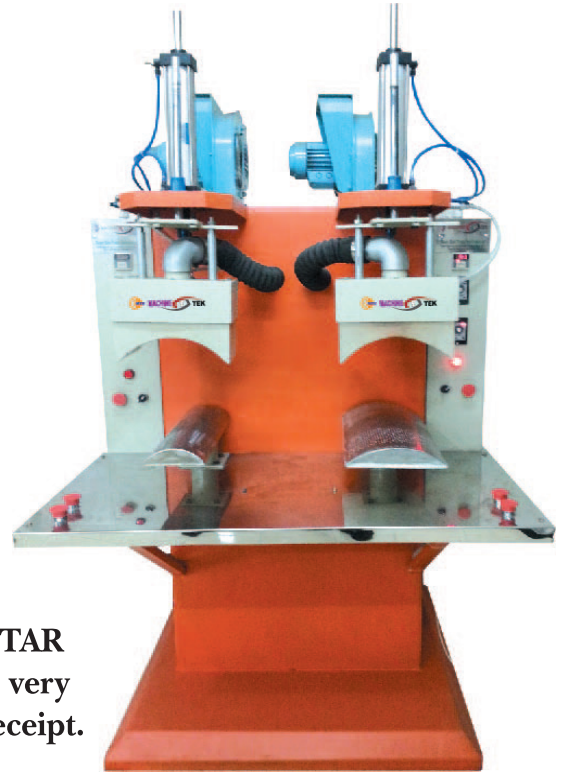

3D Crinkle with Vacuum is designed by TEAM STAR as an alternative solution for crinkle effects. It is very Easy to complete the process according to the receipt.



- The Double Head Crinkle Machine is used to obtain permanent crinkle effects on various Parts of the garments . Due to its easy usage , it is highly preferred.
- Thanks to the heat-time control unit and ergonomic usage of the control panel Which is located on the main body.
- Total Body structure mild steel with powder coated painting & Both Head crinkle individually.



3D Crinkle 4 Head , 8 Leg

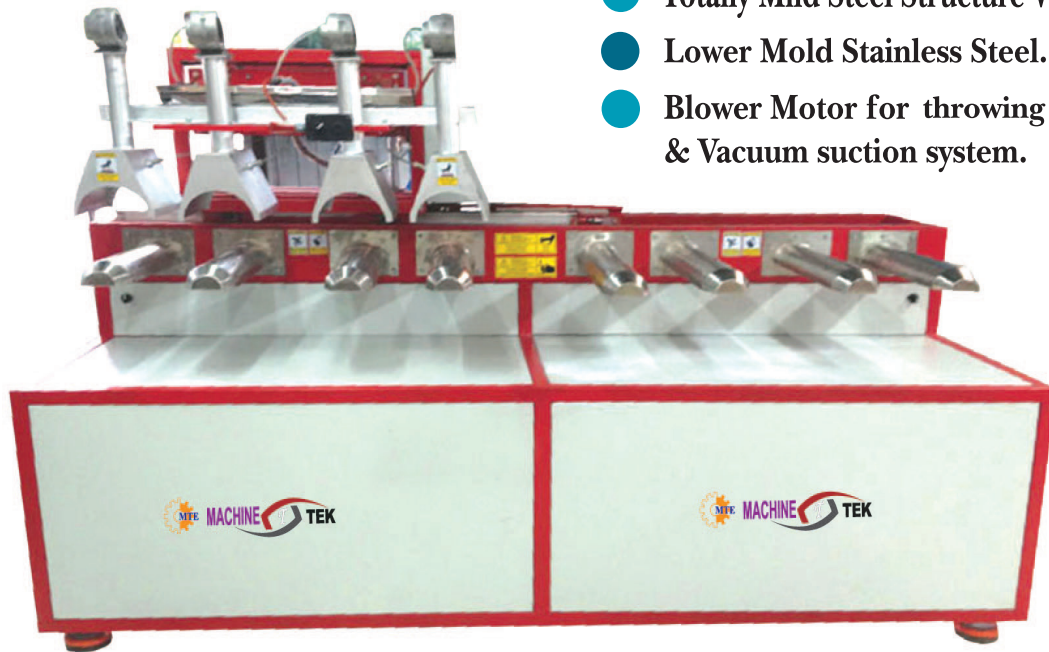

- Totally Mild Steel Structure With Paint.
- Lower Mold Stainless Steel.
- Blower Motor for throwing hot air & Vacuum suction system.

3D Crinkle , 2 head 4 Leg

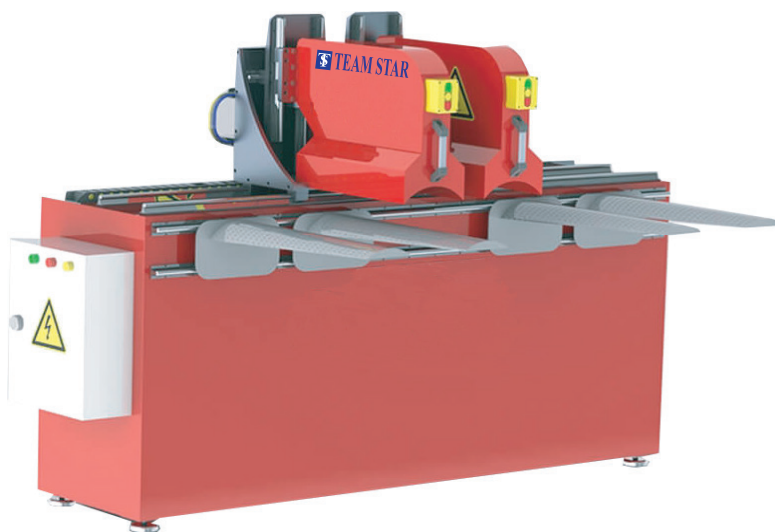

Press Crinkle Machine



Specification For Press Crinkle

- Totally Mild Steel Structure with Painting.
- Electric Vacuum Suction System.
- Lower mold are stainless steel.

Specification For Net Crinkle

- Totally Mild Steel Structure with Painting.
- The main tube are stainless steel.
- Required very few air.

Net Crinkle Machine

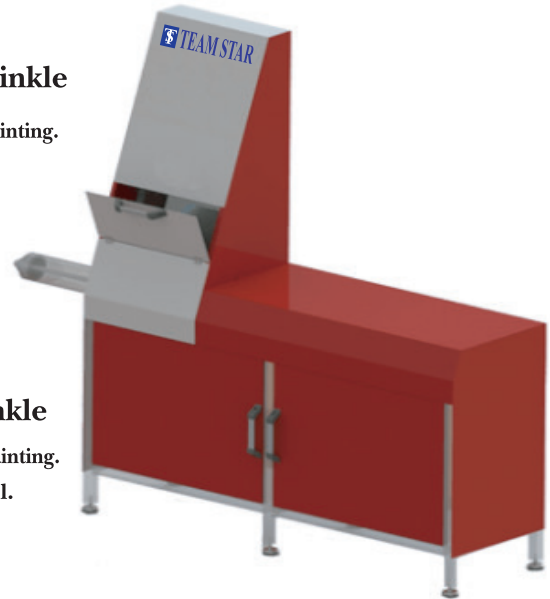

Crinkle Machine

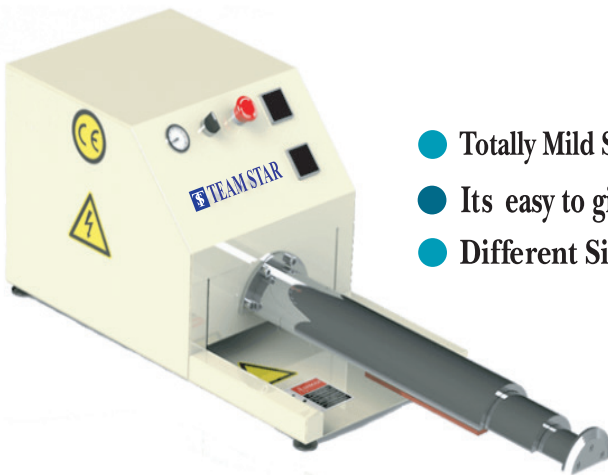

- Totally Mild Steel Structure with Painting.
- Its easy to give the crinkle effects on desired parts on garments.
- Different Size of head are stainless steel.



Brushing Machine

Our Quality & Designs are Same as Turkey.

- Totally Mild Steel With Painting.
- Auto & Manual Moving Available.
- Air In & Out With Pressure Meter.
- There are two more buttons for left and right turning also.
- It is easy to change rubber when it is needed
- System Requirements: 380 V 50 Hz / 6 bar air
- Pressure inside the Rubber Tube: 150 - 200 mbar



Horizontal Type

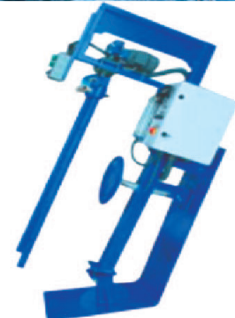

Automatic Horizontal & Vertical Brush Machine.



Tilting Position



Vertical Type



P.P Spray Cabinet



Our Quality & Designs are Same as Turkey.

The sprayer on a garment is very important for the final look.

MTK Developed different kind of spraying solutions such as spraying cabinets from 1 to 10 mannequins.



P.P Spray Cabinet

Our Quality & Designs are Same as Turkey.

We are able to provide 1 to 10 Mannequins P.P Spray Cabinet.

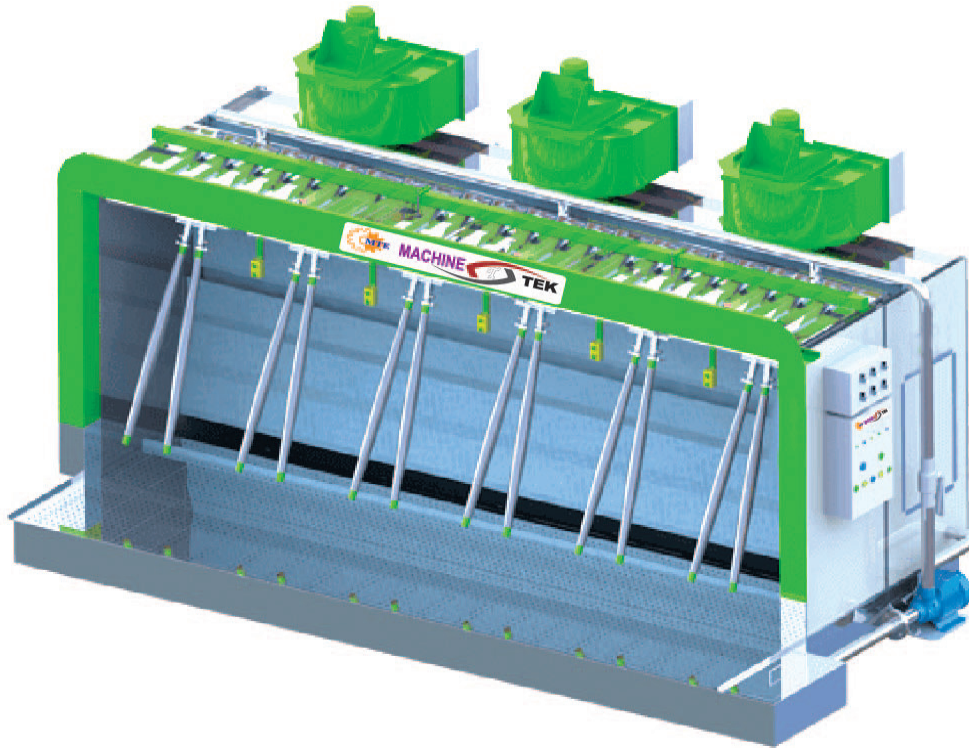

SPECIFICATION:

- The construction of chemical application cabinet consists of Stainless steel panels. the water tank & filtration tank having thickness is 2mm Stainless Steel. the side area having thickness 1.5mm
- Working platforms are also stainless steel 304G.
- Individual Blower for air suction.
- Air In & Out auto by air controlling pressure meter.
- Top frame are mild steel box with painting.
- There is a double filtration system for the water, which is carried by the pump from the bottom tank to the one located on top of the cabinet. By this double filtration system, the impurity of water is prevented. The water used in the system is discharged by an emptying valve.
- The length of cabinet varies depending on the number of mannequins.



Box Type Oven

Our Quality & Designs are Same as Turkey.

We are able to provide 10 pcs to 300 pcs .



- Box Type Ovens with trolley consist of demounted sandwich type panels. The insulation material used between the panels is 60kg/m³ rock wool and glass wool.
- The heating unit is made of stainless steel , there is no flame , fire , soot , pollution, dust coming up to the jeans so there is no mark , shade or smell on the jeans.
- There are special air ducts and blowing vents inside the oven in order to assure homogeneous distribution of hot air through the oven.
- The oven reaches to set temperature at start-up within 25-30 minutes. The maximum temperature difference between all the points inside the oven is 30C. As reaching the set temperature, the automatic temperature limiter is activated so that the set temp. remains constant. Thus, the most suitable working circumstances are obtained.
- Oven is used freely on normal ground and channels at the bottom of oven to help trolley getting inside freely.
- Natural gas, LPG tubes, fuel oil or electrical heating options available.
- Minimum energy consumption, maximum output will get.



Conveyor Oven

Our Quality & Designs are Same as Turkey.



Dip Dyeing Machine



In Garments Dyeing , Dip dyeing is becoming more popular day by day for the fashion trend and customer demand. Due to cheap & easy process it is also popular to the manufacturers.



Dip Dyeing Machine



**Giving
Brilliant
Shades of
True Color.**

We are able to provide 10 pcs to 300 pcs capacity.

This machine can dye multi - colour products. The lifting operation can be set to all automatic or manual control. it is easy to operate & it's widely used for dyeing Sweater, patterned yarns or shirts and pants of various colours. we have the highest technology for Dip Dyeing machine such as PLC Automation, touch screen controller.

- The water tank fill with chemical and color, it is made with 316 stainless steel with anti-corrosion, for the strong chemical may damage the tank .
- There are the steam heating pipe under the machine to make the water temperature same.
- The machine with hydraulic stations to control the garment up and down. It is very stable. And there is water circulation to prevent the chemical precipitation.



Grinding Machine

Grinding Machine has been designed by Team Star. This machine is used to grind some parts of the denim jeans. It runs automatically after press the start button.

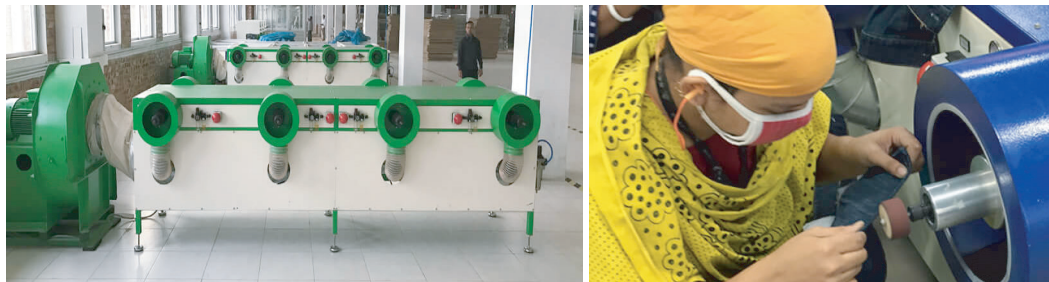
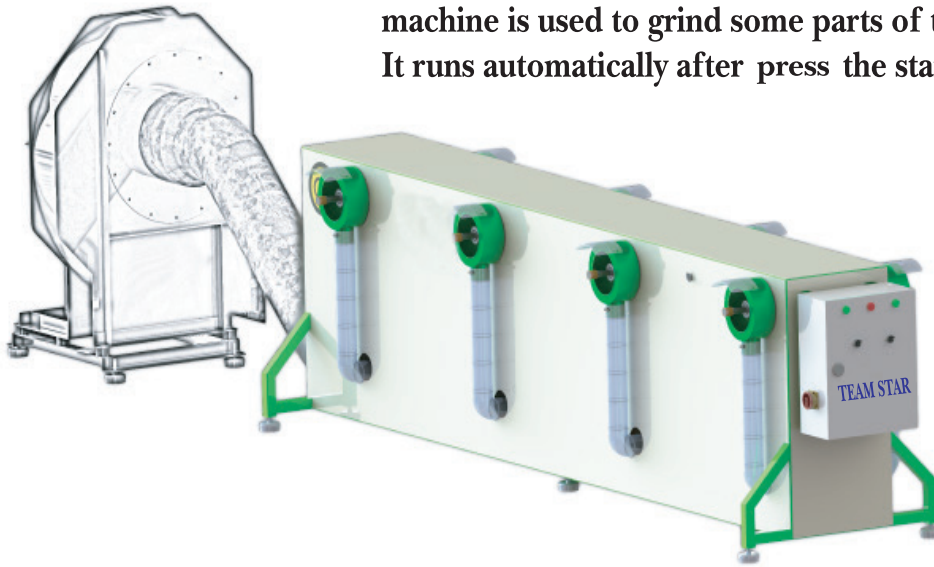

Automatic Jeans Reverse Machine

Jeans reverse machine is a kind of high efficiency reverse machine for jeans & trousers which can supply an enough suction while vacuum pump running in high speed then to suck the trousers and reverse it.

Some Features Of Jeans reverse machine :

1. High efficiency and easy to use .
2. Low consumption, environmental.
3. To choose automatic or manual operating based on requirement.



Scraping Machine With Mold



- Air filling & discharging are controlled by the button on the machine.
- Easy to change the molds.
- Easy to change the rubber when it's needed .
- Automatic air filling to avoid bursting rubber.

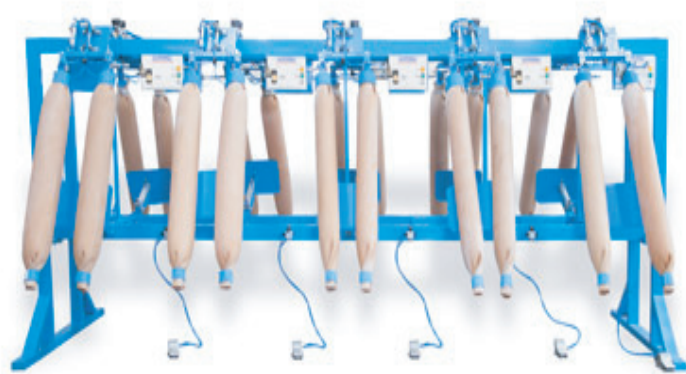

Fusing Machine (Steam Heated)



Totally Mild Steel Structure With painting.
Pneumatic controlling system.

Hot Air Dryer / Bamboo Dryer

This Machine establishes to blow the cold breeze and blow the hot place with a draught.

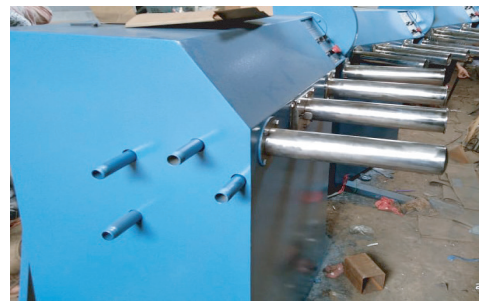

Jeans Destroying (Damage) Machine



Destroy Machine has been designed by Team Star. This machine is used to fray some parts out of the denim jeans. It runs automatically with motor system after giving start by pedal.

Jacket Mannequin



Winch Dyeing Machine

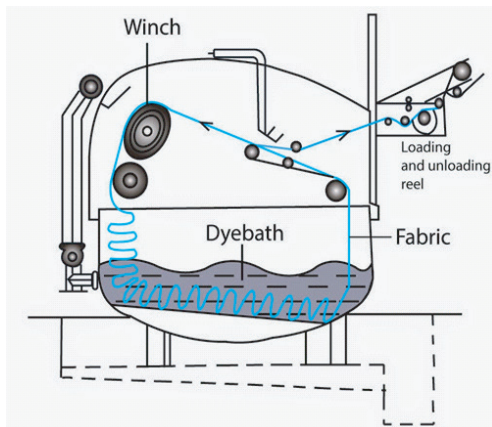
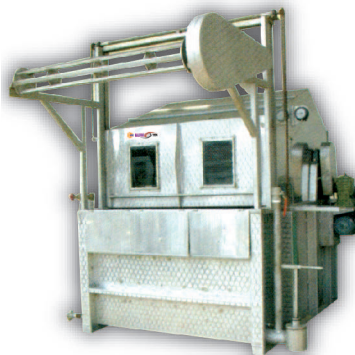
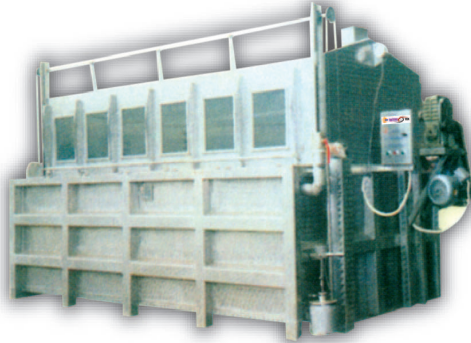

The Winch Dyeing Machine, offered by us, is widely appreciated for easy operation, specific application design and long lasting service life. The user-friendly Winch Dyeing Machine is easy to install and has durable finish standards. The body of the machine is fabricated from premium quality Stainless Steel

We have the highest technology such as PLC automation controller , Touch screen monitor & Water flow meter.

Model NO	Capacity (KG)	Dimension (W X D X H) (mm)	Motor Power (KW)
MTK - W.D 25	25	1371 X 1320 X 900	0.75
MTK - W.D 50	50	1828 X 1930 X 900	1.1
MTK - W.D 100	100	2438 X 1930 X 900	1.5
MTK - W.D 200	200	3048 X 2235 X 925	1.5
MTK - W.D 300	300	3657 X 2235 X 925	2.2
MTK - W.D 400	400	4267 X 2540 X 925	4
MTK - W.D 500	500	4876 X 2540 X 925	5.5
MTK - W.D 600	600	5486 X 2540 X 925	5.5



Paddle Dyeing Machine



The Paddle dyeing machine is designed for modern apparel dyeing industry which is good for linen , cotton , rayon , seamless underwear after blending silk stocking and silks. it's made by high quality stainless steel ,low noise& easy operation.

We Have the highest technology such as PLC Automation programme & Water flow meter.

Model NO	Capacity (KG)	Paddle Dimension (mm)	Overall Dimension (mm) (L X W X H)	Motor Power (KW)
MTK - 2/4.4/7.7	1 / 2 / 3.5	ø 420 X 165 / 250 / 640	1900 X 900 X 1120	1.2 KW
MTK - 4.4/11/15	2 / 5 / .7	ø 432 / 250 / 672 / 915	2970 X 1120 X 1370	2.2 KW
MTK - 44	20	ø 560 X 915	1850 X 1120 X 1370	2.2 KW
MTK - 100	45	ø 700 X 1220	2240 X 1520 X 1630	2.2 KW
MTK - 150	70	ø 810 X 1560	2610 X 1680 X 1780	2.2 KW
MTK - 200	90	ø 910 X 1800	2820 X 1810 X 1880	2.2 KW
MTK - 300	135	ø 960 X 2100	3150 X 2090 X 2030	4 KW
MTK - 400	180	ø 1020 X 2380	3390 X 2130 X 2030	4 KW
MTK - 500	225	ø 1070 X 2380	3660 X 2365 X 2085	4 KW
MTK - 600	275	ø 1080 X 2940	3990 X 2410 X 2160	5.5 KW

Frequency Inverter

We have accumulated huge experience on real applications and have enjoyed a great popularity among factory automation markets. With the flexibility on wide capacity range and specialized models, Our AC Drives can fit in each application you need.

Available POWER : 0.75KW - 315 KW



3 Phase input R S T

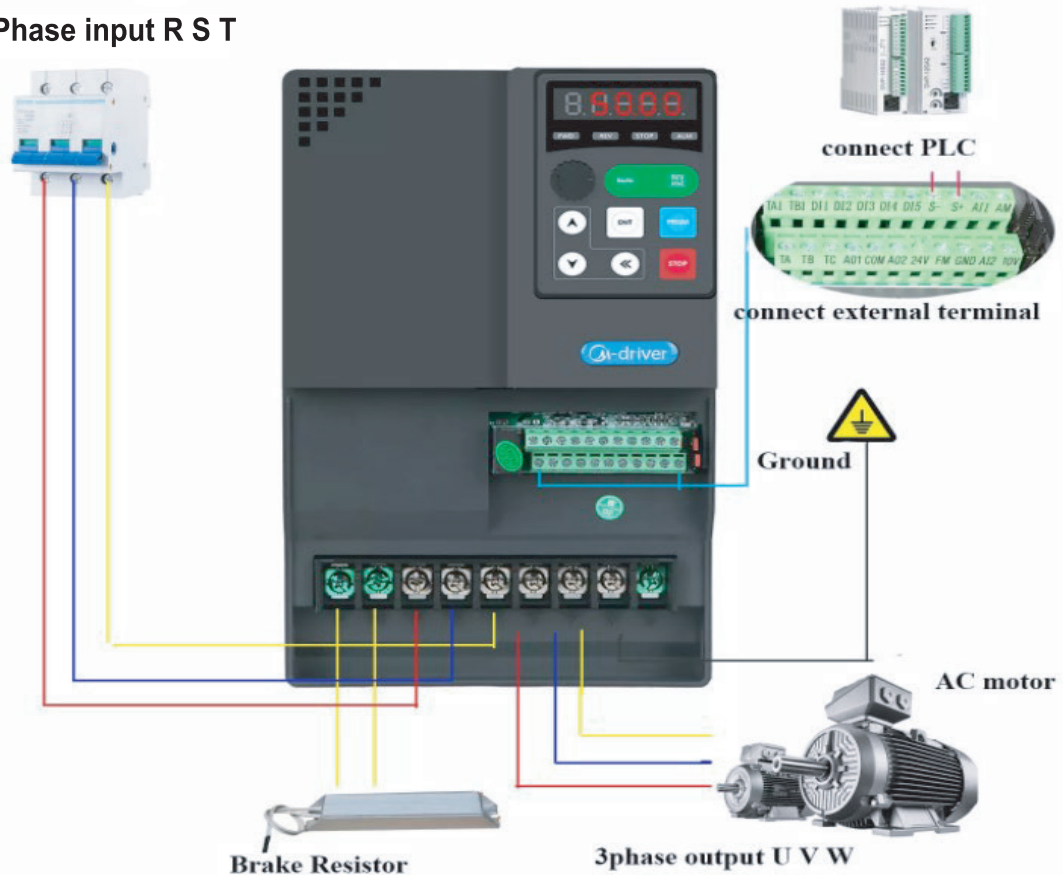

Frequency Inverter



PLC Automation Item

Programmable logic controller (PLC) is a control system using electronic operations. Its easy storing procedures, handy extending principles, functions of sequential/position control, timed counting and input/output control are widely applied to the field of industrial automation control.



PLC Automation item & Servo Motor

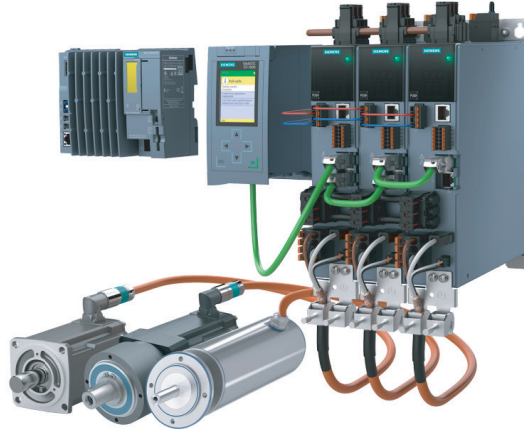

Different Types Of Flow Meter

A flow meter (or flow sensor) is an instrument used to measure linear, nonlinear, mass or volumetric flow rate of a liquid, gas & air. We are able to provide you different types of flow meter with different sizes, such as Turbine & Electromagnetic type water flow meter, Vortex steam flow meter, Gas & Air flow meter.



Turbine Type Water Flow Meter, Size : DN 50



Turbine Type Water Flow Meter, Size : DN 80



Different Types Of Flow Meter



Electromagnetic Type Water Flow Meter , Size : DN 50 & DN 80



Vortex Steam Flow Meter



Gas Flow Meter

Digital Air Flow Meter



Heat Exchanger

Heat exchangers are devices that transfer heat to achieve desired heating. An important design aspect of heat exchanger technology is the selection of appropriate materials to conduct and transfer heat fast and efficiently.

Copper has many desirable properties for thermally efficient and durable heat exchangers.

First and foremost, copper is an excellent conductor of heat. This means copper's high thermal conductivity allows heat to pass through it quickly.

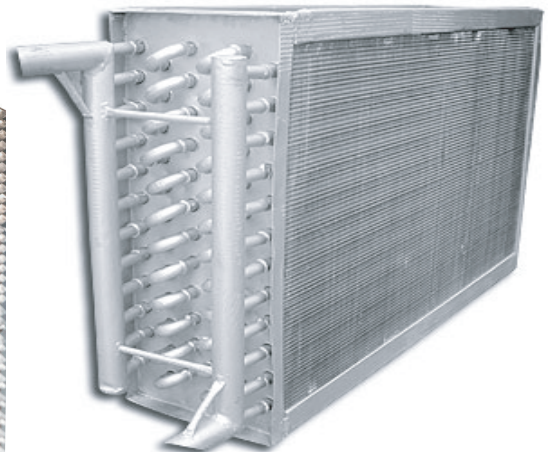
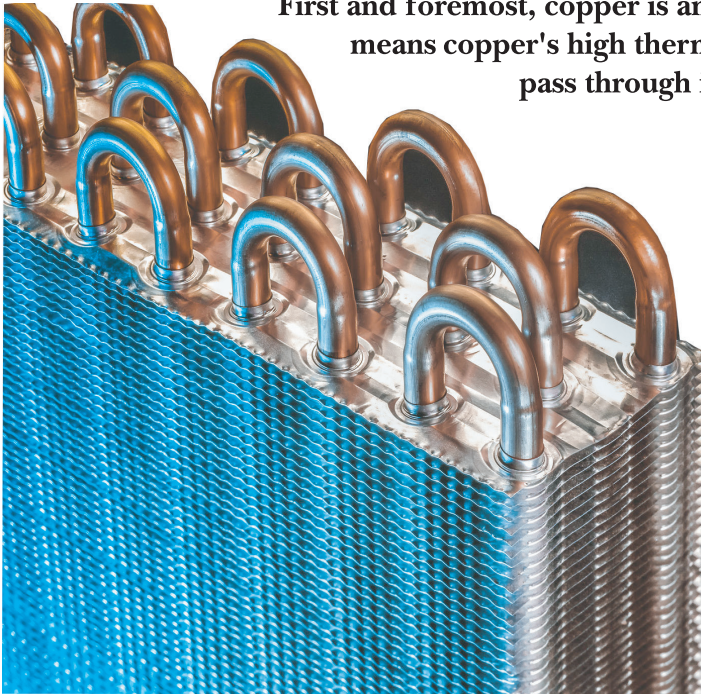

**HIGHLY ECOFRIENDLY
AUTO VENT OPENING,
WITH PNEUMATIC
GUAGE**

**GREATER EVAPORATION
GIVING CRISPY DRY
SUSTAINABLE
FABRIC**

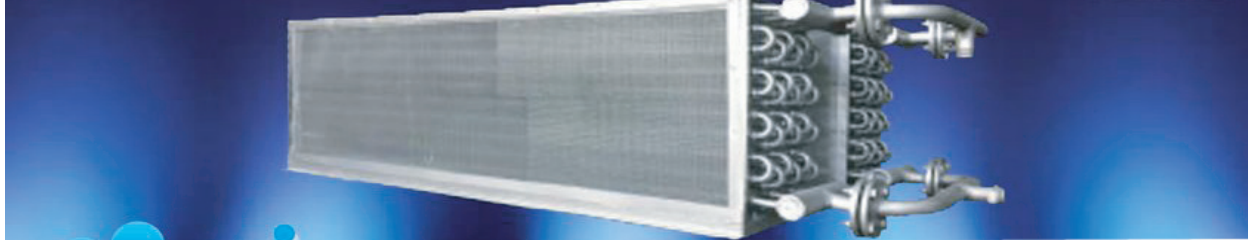

Chemical Mixing Tank



Basket

QC Table



Eye Shower & Head Shower



Whisker Stand



Grinding Machine & Stones

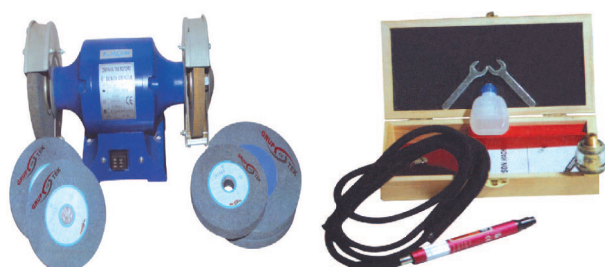

Sand Paper



Acid Wash Ball



Plastic Attacher Machine



Tag Pin Roll



Attacher Machine Needle

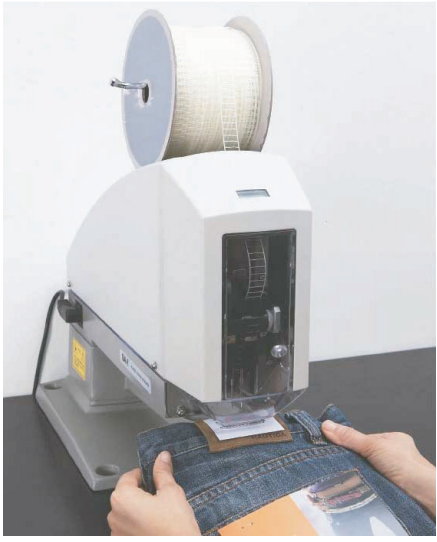

Attacher Machine Knife & Needle



Attacher Machine Solenoid valve



Rubber Tube



Washing Towel

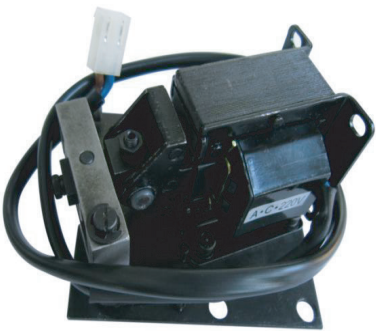
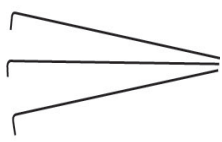

S.S Trolley

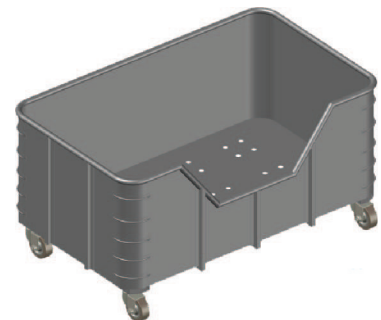

Plastic Basket With Frame



Industrial Heavy Duty Rack



Different types of bearing



Laser Cutting Machine



We have the highest technological auto cnc laser cutting machine. any design can smoothly cut by this laser machine on stainless steel , Mild steel , Aluminium.

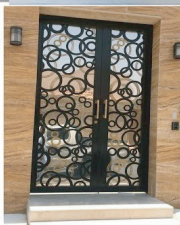
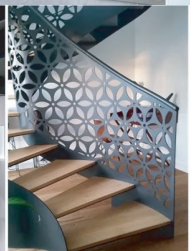
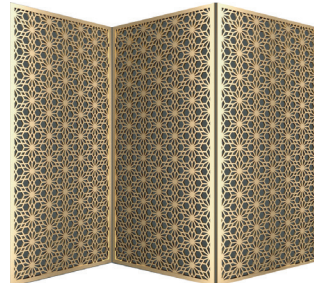
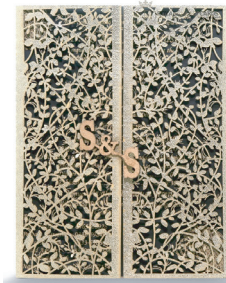
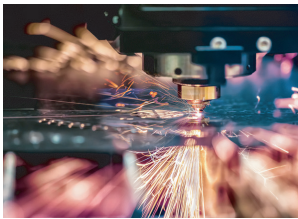

Different Types of Electrical Item

We are able to provide all kinds of electric item like -MCB , MCCB , Magnetic contact ,Thermal overload relay , Phase failure device , Digital timer , Digital temperature controller , Dual Timer, relay , all types of switch & proximity sensor etc. We can ensure the product Quality.



Different Size Belt



Complete Erection Work

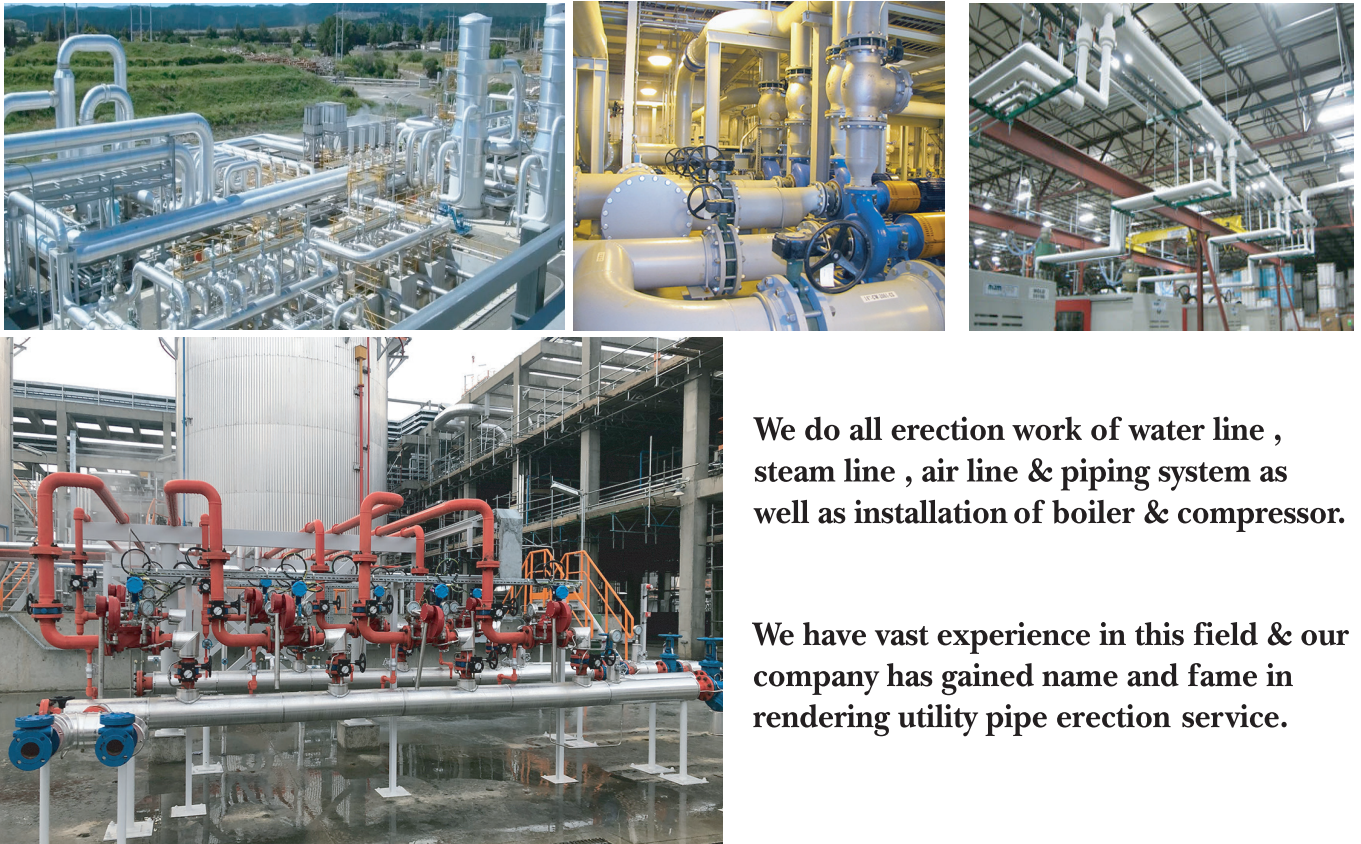

We do all erection work of water line , steam line , air line & piping system as well as installation of boiler & compressor.

We have vast experience in this field & our company has gained name and fame in rendering utility pipe erection service.



Some Factories Picture Where Our Machine are Installed





Certificates

Government of the People's Republic of Bangladesh
Office of the Chief Controller of Imports and Exports
Import Registration Certificate (IRC)

Industrial
IRC No: **138113849583**

This is to certify that until further orders **TEAM STAR TECHNOLOGY**, Office Address: House-6, Dag-466, Nuhunbar Bazarolu, Uttara, Turag, Dhaka-1230, Factory Address: House-6, Dag-466, Nuhunbar Bazarolu, Uttara, Turag, Dhaka-1230 is hereby registered as a **Manufacturer** of Office of the Chief Controller of Imports and Exports under the jurisdiction of Office of the Controller of Imports and Exports, Dhaka with following terms and conditions:

Company's Particulars:

1. E-TIN	: 138113849583
2. Previous IRC No	: N/A
3. Type of Industry (Sector)	: 2759 - MANUFACTURING, 27599 - Manufacture of other domestic appliances n.e.c.
4. IRC Status	: First Issue
5. Sponsoring Authority Name, Registration No & Date	: Bangladesh Investment Development Authority (BIDA), I-20220420004205-H, 2022-04-28
6. Nominated Bank Name & Branch	: Bank Asia Ltd., Sonargaon Janapath Road
7. Import Slab	: Half Yearly: 49,64,900 Taka; Yearly: 99,28,800 Taka
8. First Issue Date	: 02 June, 2022
9. Valid up to	: 30 June, 2022
10. Last Updated Date	: 02 June, 2022

Terms & condition:

- This Registration Certificate will have to be renewed every financial year.
- Prohibited goods cannot be imported and in the case of 2, controlled/restricted goods, all the terms and conditions of the import policy order should be maintained properly.
- Without any permission of the Chief Controller of Imports & Exports or any other officer authorized by him, this Registration Certificate cannot be transferred.
- If any Importer, Exporter or Indentor violates any provision of the Importers, Exporters & Indentors (Registration) Order, 1981 or any other laws, the registration may be suspended or cancelled.
- Any kind of fraud, forgery and misrepresentation is punishable under ICT Act, 2006 and in such cases the registration may be suspended and cancelled by the authority.
- The authority reserves the right to cancel the registration certificate at any time without assigning any reason whatsoever.

N.B. This is a system generated certificate requires no manual signature.

Government of the People's Republic of Bangladesh
Office of the Chief Controller of Imports and Exports
Export Registration Certificate (ERC)

ERC No: **138113849583**

This is to certify that until further orders **TEAM STAR TECHNOLOGY**, Address: House-6, Dag-466, Nuhun Bazar Bazarolu, Turag, Dhaka-1230 is hereby registered as an **Exporter** of Office of the Chief Controller of Imports and Exports under the jurisdiction of Office of the Controller of Imports and Exports, Dhaka with following terms and conditions:

Company's Particulars:

1. E-TIN	: 138113849583
2. Previous ERC No	: N/A
3. Nominated Bank Name & Branch	: Bank Asia Ltd., Sonargaon Janapath Road
4. First Issue Date	: 18 April, 2022
5. Valid up to	: 30 June, 2022
6. Last Updated Date	: 18 April, 2022

Terms & conditions:

- This Registration Certificate will have to be renewed every financial year.
- Prohibited goods cannot be exported and in the case of controlled/restricted goods, all the terms and conditions of the export policy order should be maintained properly.
- Without any permission of the Chief Controller of Imports & Exports or any other officer authorized by him, this Registration Certificate cannot be transferred.
- If any Importer, Exporter or Indentor violates any provision of the Importers, Exporters & Indentors (Registration) Order, 1981 or any other laws, the registration may be suspended or cancelled.
- Any kind of fraud, forgery and misrepresentation is punishable under ICT Act, 2006 and in such cases the registration may be suspended or cancelled by the authority.
- The authority reserves the right to cancel the registration certificate at any time without assigning any reason whatsoever.

N.B. This is a system generated certificate requires no manual signature.

জাতীয় ক্ষুদ্র ও কুটির শিল্প সমিতি, বাংলাদেশ (নাসচি)
National Association of Small & Cottage Industries of Bangladesh (NASCI)

MEMBERSHIP CERTIFICATE

Certificate No: 7454

Issued from Head Office

Certified that Mr. **TEAM STAR TECHNOLOGY**
at _____ House-6, Dag-466, Nuhun Bazar, Turag, Dhaka-1230
is a member of this Association.

This Certificate shall be valid up to 30th June, 2022 unless otherwise notified to the Report: Export Licensing Authority / NARI / NSIC / EPZ / SASEP / Subsidized Bank concerned.

Issued on this, 27th December, day of, 2022.

করণোপাধি **শিখরোপাধি**

স্বাক্ষরিত

০২ জুন ২০২২

০২ জুন ২০২২





TEAM STAR

Complete Washing & Laundry Solutions.

Our Honourable Customers

- ☞ HAMEEM GROUP
- ☞ SQUARE GROUP
- ☞ BEXIMCO GROUP
- ☞ NATURAL GROUP
- ☞ STANDARD GROUP
- ☞ STERLING GROUP
- ☞ WINDY GROUP
- ☞ NASSA GROUP
- ☞ SEPAL GROUP
- ☞ NOMAN GROUP
- ☞ ENVOY GROUP
- ☞ AJI GROUP
- ☞ AB GROUP
- ☞ BITOPI GROUP
- ☞ DEKKO GROUP
- ☞ AKH GROUP
- ☞ SHARMIN GROUP
- ☞ ANANTA GROUP
- ☞ JAMUNA GROUP.
- ☞ A & A TROUSER LTD.
- ☞ DENIM ASIA LTD.
- ☞ TROPICAL KNITEX LTD.
- ☞ YOUNG ONE BANGLADESH (KEPZ)
- ☞ NORP KNIT INDUSTRIES LTD.
- ☞ RADISSON WASHING
- ☞ UNIQUE WASHING & DYEING
- ☞ VERTEX WEAR LTD.
- ☞ JERKIN GROUP
- ☞ VERSATILE APPARELS LTD.
- ☞ NEW ASIA GROUP
- ☞ AZMAT GROUP
- ☞ EURO ZONE GROUP
- ☞ NAKANO WASHING
- ☞ PACIFIC JEANS LTD
- ☞ Pakiza Group
- ☞ Moonlight Wash Ltd.
- ☞ SP Garments & Washing Ltd.
- ☞ Renaissance Group
- ☞ Roar Fashion Ltd.
- ☞ Bandbox Ltd.
- ☞ DMC Apparels Ltd.

**YOU ARE CORDIALLY
WELCOME TO VISIT US.**

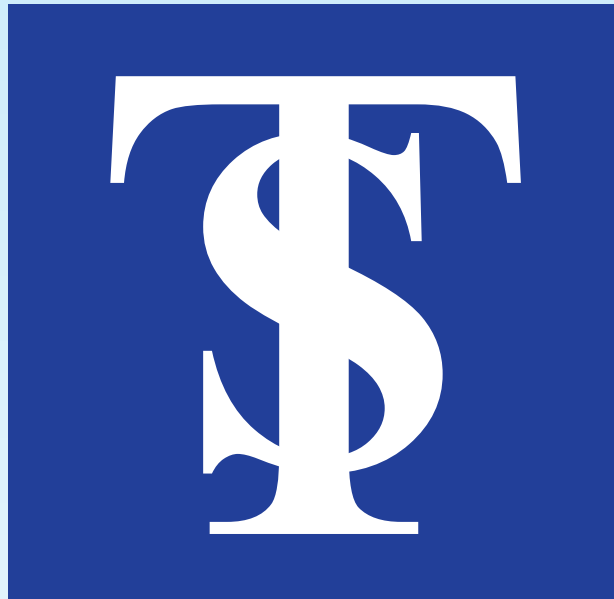

TEAM STAR

COMPLETE WASHING & LAUNDRY SOLUTIONS.

Address : Kamarpara, Natun Bazar, Uttara, Sector 10, Dhaka-1230
Email: tstbd7@gmail.com, offic.teamstar@gmail.com, Contact : 01711-281521, 01924-081827
Web : www.teamstarbd.com, FB: facebook.com/tstmte